

# **LAMPARAS DE DIAGNOSTICO**

OLIVABIOMEDICA S.L  
C/ALFEREZ PROVISIONAL 74  
LAS PALMAS DE GRAN CANARIA  
\*\*\*\*\*

TELEFONOS: 679991550  
619288517

E-MAIL: [olivabiomedica@telefonica.net](mailto:olivabiomedica@telefonica.net)  
WEB : [www.olivabiomedica.com](http://www.olivabiomedica.com)

## **INDICE**

**1- LAMPARAS COMPATIBLE HEINE**

**2- LAMPARAS COMPATIBLE RIESTER**













**3- LAMPARAS COMPATIBLE WELCH ALLYN**

**4- BATERIAS COMPATIBLE WELCH ALLYN**



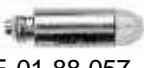











## LÁMPARAS COMPATIBLES HEINE

29

LÁMPARA	TIPO	VOLTAJE	GAS
 HE-01.88.035/ K/X	LARINGOSCOPIO F.O AMNIOSCOPIO	2,5 V	KRIPTON HALOGENA XENON
 HE-01-88-037/V/K/X	MINI 2000, ALPHA,	2,5V	VACIO KRIPTON HALOGENA XENON
 HE-01-88-038	MIROFLEX OFTALMOSCOPIO, DELTA 10	2,5V	HALOGENA
 HE-01-88-039		2,5V	HALOGENA
 HE-01-88-040	PROCTOSCOPIO	2,7V	HALOGENA
 HE-01-88-041/ K	MINI FIBRALUX MINI 2000 <i>Combilight y ambilight</i>	2,5v	KRIPTON HALOGENA
 HE-01-88-042 /K	OFTALMOSCOPIO ALPHA., FOCALUX MINI 2000, MIROFLEX.	2,5V	KRIPTON HALOGENA
 HE-01-88-056 /K	OTOSCOPIO MINILUX, MINI 2000	2,5V	KRIPTON HALOGENA
 HE-01-88-057 /K	ESPEJO LARINGEO RECTO	2,7V	KRIPTON HALOGENA
 HE-01-88-059 K/V	LARINGOSCOPIO ESTANDAR	2,5V	VACIO KRIPTON HALOGENA
 HE-01-88-069	OFTALMOSCOPIO BETA 2000	2,5V	HALOGENA
 HE-01-88-077 /X	OTOSCOPIOS RETINOSCOPIOS	2,5V	HALOGENA XENON



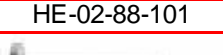











# LÁMPARAS COMPATIBLES HEINE

30

LÁMPARA	TIPO	VOLTAJE	GAS
 HE-02-88-044/X	LARINGOSCOPIO F.O AMNIOSCOPIO	3,5V	HALOGENA XENON
 HE-02-88-046	MIROFLEX OFTALMOSCOPIO, DELTA 10	3,5V	HALOGENA
 HE-02-88-049/X	MINI 2000, ALPHA,	3,5V	HALOGENA XENON
 HE-02-88-050	OFTALMOSCOPIO INDIRECTO	3,5V	HALOGENA
 HE-02-88-051	PROCTOSCOPIO	3,5V	HALOGENA
 HE-02-88-062	ESPEJO LARINGEO CURVO	3,5V	HALOGENA
 HE-02-88-063	ESPEJO LARINGEO RECTO	3,5V	HALOGENA
 HE-02-88-070	OFTALMOSCOPIO BETA 2000	3,5V	HALOGENA
 HE-02-88-078/X	OTOSCOPIOS RETINOSCOPIOS	3,5V	HALOGENA XENON
 HE-02-88-091	FOCALUX	3,5V	HALOGENA
 HE-02-88-101			
 HE-04-88-068	OMEGA 100/150/200 CABEZAL LUZ SL350	6V	HALOGENA













## LÁMPARAS COMPATIBLE RIESTER

31

LÁMPARA	TIPO	VOLTAJE	GAS
 RI-10421	OTOSCOPIO UNI	2,7V	VACIO
 RI-10424	OFTALMOSCOPIO MAY	2,7V	VACIO
 RI-10473	OFTALMOSCOPIO PENSCOPE	2,7V	VACIO
 RI-10591	OFTALMOSCOPIO MAY	2,5V	HALOGENA
 RI-10592	OTOSCOPIO Y BRAZO ILUMINADO	3,5V	XENON
 RI-10593	OFTALMOSCOPIO MAY	3,5V	XENON
 RI-10600	OTOSCOPIO RIMINI, RI-STAR, RI-SCOPE	2,5V	HALOGENA
 RI-10601	OTOSCOPIO RIMINI, RI-STAR, RI-SCOPE	3,5V	HALOGENA
 RI-10602	OTOSCOPIO CIRUGIA RI-SCOPE	2,5V	HALOGENA
 RI-10603	OTOSCOPIO CIRUGIA RI-SCOPE	3,5V	HALOGENA
 RI-10605	OFTALMOSCOPIO RIMINI RI-STAR, RI-SCOPE, RI-DERMA	2,5V	HALOGENA
 RI-10606	OFTALMOSCOPIO RI-STAR, RI-SCOPE, RI-DERMA	3,5V	HALOGENA
 RI-10607	OTOSCOPIO RIMINI, RI-STAR, RI-SCOPE	3,5V	XENON
 RI-10608	OFTALMOSCOPIO RIMINI RI-STAR, RI-SCOPE, RI-DERMA	3,5V	XENON
 RI-10609	OTOSCOPIO CIRUGIA RI-SCOPE	3,5V	XENON





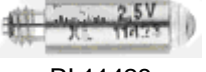
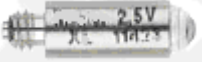











# LÁMPARAS COMPATIBLE RIESTER

32

LÁMPARA	TIPO	VOLTAJE	GAS
 RI-10610		3,5V	XENON
 RI-10611		3,5V	XENON
 RI-10615		2,5V	HALOGENA
 RI-10616		3,5V	HALOGENA
 RI-10620		2,5V	HALOGENA
 RI-10621		3,5V	HALOGENA
 RI-11178	FORTELUX	2,5V	HALOGENA
 RI-11320	RI-CLAR	6V	HALOGENA
 RI-11378	LARINGOSCOPIO PALAS 00-1	2,7V	VACIO
 RI-11379	LARINGOSCOPIO PALAS 2-4	2,7V	VACIO
 RI-11380	LARINGOSCOPIO PALAS 00-1	2,7V	VACIO
 RI-11381	LARINGOSCOPIO PALAS 2-4	2,7V	VACIO
 RI-11428	LARINGOSCOPIO F.O. XL 2,5 V	2,5V	XENON
 RI-11429	LARINGOSCOPIO F.O. XL 3,5 V	3,5V	XENON
RI-11431		2,5	HALOGENA

# LÁMPARAS COMPATIBLE WELCH ALLYN













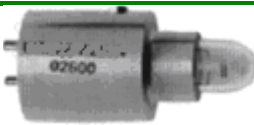



9

LAMPARA	TIPO	VOLTAJE	GAS
 WA-100	LARINGOSCOPIO PEDIATRICOS	2,5V	VACIO
 WA-200	LARINGOSCOPIO ADULTO	2,5V	VACIO
 WA-300	 60835	3,5V	HALOGENA
 WA-600	Sigmoidoscope  30800	2,5V	VACIO
 WA-900	Ophthalmoscopes 10600 121 110 Retinoscopes 17600 17610	2,5V	VACIO
 WA-0200	Binocular Indirect Ophthalmoscope 125 Series 	4,65	HALOGENA
 WA-1300	Tongue Blade Holder  28000	2,5	VACIO
 WA-1400	PEN LITE 77800	2,5	VACIO
 WA-1800	RETINOSCOPIO 17200 – 17700	2,5V	VACIO
 WA-2000	Headlights  45003	7V	VACIO
 WA-2100	OFTALMOSCOPIO 11500	2,7V	VACIO
 WA-2200	OTOSCOPIO 22900	2,5V	VACIO













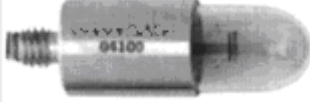
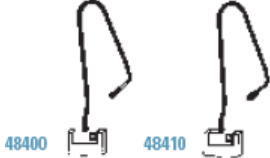

# LÁMPARAS COMPATIBLE WELCH ALLYN

10

LAMPARA	TIPO	VOLTAJE	GAS
 WA-2300	OFTALMOSCOPIO 12900	2,5	VACIO
 WA-2500	Headlight  46003	6V	VACIO
 WA-2600	Headlight  49003	6V	VACIO
WA-2800	OFTALMOSCOPIO KLINIC 19090	2,5V	VACIO
WA-2900	OTOSCOPIO KLINIC 29090	2,5V	VACIO
 WA-3000	11710, 12400, 47300, 11600, 11602, 11610, 18000	3,5V	HALOGENA
 WA-3100	25020, 21700, 20200, 20200, 73500, 28100, 27000, 27050, 26538, 26530, 41100, 43300	3,5V	HALOGENA
 WA-3300	11511, 11500	2,5V	VACIO HALOGENA
 WA-3400	Otoscope 2.5 V Handle Adapter  24031 73550 27200 27250 411	2,5V	HALOGENA
WA-03500	VIDEO OTOSCOPIO COMPAC	3,5V	HALOGENA
 WA-3600	Disposable Laryngoscope Illuminator  60500	2,5V	VACIO
 WA-3700	Retinoscope  18100	3,5V	HALOGENA
 WA-3800	PanOptic Ophthalmoscopes  11810 11820		
 WA-3900	12810, 11110	2,5V	HALOGENA







# LÁMPARAS COMPATIBLE WELCH ALLYN

11

LAMPARA	TIPO	VOLTAJE	GAS
 WA-4050	45250	21V/150W	HALOGENA
 WA-4100	 48400 48410	14,5	HALOGENA
 WA-4200	LAMPARAS EXAMEN 48700, 48600, 48610, 48625, 48635		HALOGENA
 WA-4300	OFTALMOSCOPIO 11400	2,5V	VACIO
 WA-4400	OFTALMOSCOPIO 11470, 11475, 11400, 11411	2,5V	HALOGENA
 WA-4500	RETINOSCOPIO 18010	3,5V	HALOGENA
 WA-4600	RETINOSCOPIO 17710	3,5V	HALOGENA
 WA-4700	LARINGOSCOPIO PALAS 1-2	2,5V	VACIO
 WA-4800	LARINGOSCOPIO PALAS 2-4	2,5V	VACIO
 WA-04900	OFTALMOSCOPIO 11720, 11730, 11620, 11630	3,5V	HALOGENA
 WA-6000	MANGO LARINGOSCOPIO 60813, 60814, 60715, 60815, 60803, 60804	2,5V	HALOGENA
 WA-6100	LAMPARA DE EXAMEN 48435	14,5V	HALOGENA
 WA-6200	AUDIOSCOPE 23300, 23020, 23040	3,5V	HALOGENA

















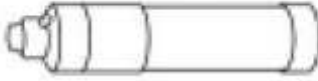
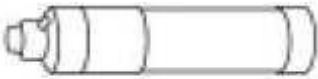

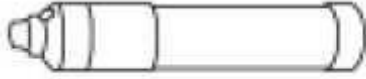
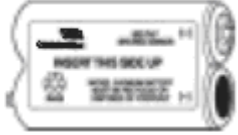
## LÁMPARAS COMPATIBLE WELCH ALLYN

12

LAMPARA	TIPO	VOLTAJE	GAS
 WA-6300	LAMPARAS DE EXAMEN 44100 Y 44110	12V 20W	HALOGENA
 WA-6400	LAMPARA DE EXAMEN 44200	25W	HALOGENA
 WA-6500	OTOSCOPIO MACROVIEW 23810 23820		
 WA-7200	RETINOSCOPIO 17200	2,5V	HALOGENA
 WA-7600	PENLITE	2,5V	HALOGENA
 WA-7800	ESPECULO VAGINAL 78000, 73210, 73200	6V	VACIO
 WA-8100	LAMPARA DE EXAMEN 48100	12V	HALOGENA
 WA-8200	RETINOSCOPIO 18245, 18200, 18235	3,5V	HALOGENA
 WA-8300	RETINOSCOPIO 18300	3,5V	HALOGENA
 WA-8400	RETINOSCOPIO 93300	2,5V	HALOGENA
 WA-8500	LUMIVIEW 20502	3,6V	HALOGENA
 WA-8800	REFERENCIA 49500		
	REFERENCIA 49500		

## BATERIAS COMPATIBLE WELCH ALLYN

37

BATERIA	INSTRUMENTO	VOLTAJE
 WA-72300	 71000-A, 71020-A, 71000-C, 71020-C, 71055-C	3,5V
 WA-72200	 71670   71000 71020	3,5V
 WA-72000	 70700 71500   60700	2,5V
 WA-72100	 617 handles, 717 handles	2,5V
 WA-72610	<b>CompacSet</b>  93400	
 WA-72600	<b>PocketScope</b>  72800	
 WA-72240	<b>Binocular Indirect Ophthalmoscope</b>  12000	
 WA-71960	<b>719 Lithium Ion Handle</b>  71900	
 WA-72420	<b>SureSight</b>  14010	

